

1. Which of the following expressions has a value of 4?

- (A) $(16 - 12)^2$
- (B) $-|-4|$
- (C) $(96 \div 8) - 2^3$
- (D) $2^4 - 4^2$

2. Tai's baby brother weighs 3,745 grams. What is his weight in kilograms?

- (A) 0.3745 kg
- (B) 3.745 kg
- (C) 37.45 kg
- (D) 374.5 kg

3. A rectangle on a coordinate plane has vertices at $(7, 5)$, $(-7, 5)$, $(-7, -2)$, and $(7, -2)$. What is the perimeter of the rectangle?

- (A) 21 units
- (B) 34 units
- (C) 42 units
- (D) 98 units

4. Which statement represents the situation described below?

The cost c of a shirt is less than \$27.50.

- (A) $c > 27.50$
- (B) $c < 27.50$
- (C) $c = 27.50$
- (D) $27.50 < c$

5. Jayden uses the net below to design a box.

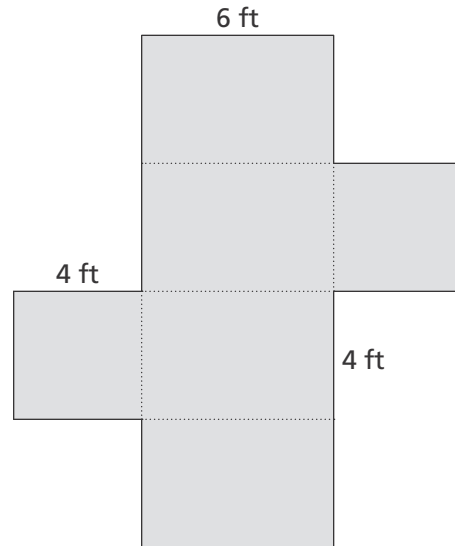

How much cardboard will Jayden need to make the box?

- (A) 60 ft^2
- (B) 96 ft^2
- (C) 128 ft^2
- (D) 144 ft^2

6. Kenji earned the test scores below in English class.

79, 91, 93, 85, 86, and 88

What are the mean and median of his test scores?

- (A) Mean: 79; Median: 93
- (B) Mean: 87; Median: 93
- (C) Mean: 87; Median: 87
- (D) Mean: 93; Median: 87

7. Which coordinate pair represents the reflection of Point A across the y-axis?

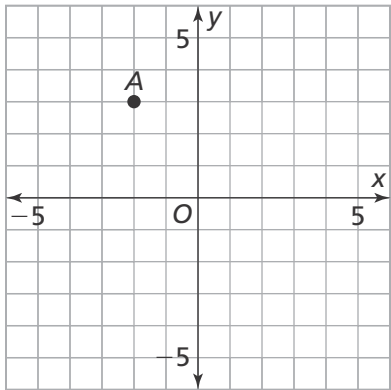

- (A) $(-2, -3)$
- (B) $(2, -3)$
- (C) $(-2, 3)$
- (D) $(2, 3)$

8. Which of the following statements about the box plot is true?

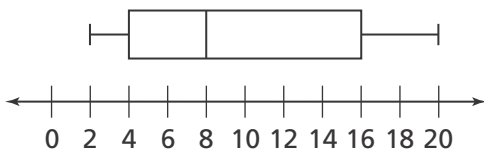

- (A) Minimum: 4
- (B) Maximum: 16
- (C) First quartile: 8
- (D) Third quartile: 16

9. The drama club spent \$8.50 per person on food for a cast party. The total cost of the food was \$229.50. How many people were at the cast party?

- (A) 27 people
- (B) 221 people
- (C) 238 people
- (D) 1,951 people

10. What are the values of a and b on the number line?

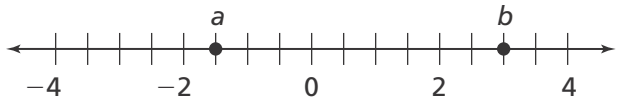

- (A) $a = 1.5, b = 2.5$
- (B) $a = -1.5, b = 3$
- (C) $a = -1.5, b = 2.5$
- (D) $a = 1.5, b = 3$

11. The boiling point of jet fuel is 329°F . Rounded to the nearest degree, what is the temperature in degrees Celsius? Use the formula $C = \frac{5}{9}(F - 32)$, where C represents degrees Celsius and F represents degrees Fahrenheit.

- (A) 165°C
- (B) 183°C
- (C) 201°C
- (D) 535°C

12. A gym charges a one-time fee of \$75 to join, plus membership dues of \$25 per month. Which equation represents the total cost, C , of belonging to the gym for m months?

- (A) $C = 25m - 75$
- (B) $C = 25m + 75$
- (C) $C = 75m + 25$
- (D) $C = 75m - 25$

13. Divide $5\frac{3}{4} \div 1\frac{1}{2}$.

- (A) $3\frac{5}{6}$
- (B) $4\frac{1}{4}$
- (C) $7\frac{1}{4}$
- (D) $8\frac{5}{8}$

14. A 2-liter bottle of juice costs \$2.80. A box containing six $\frac{1}{2}$ -liter bottles sells for \$3.90. Which option has a higher cost per liter? What is that cost?

- (A) 2-liter bottle; \$1.40
- (B) Box of six $\frac{1}{2}$ -liter bottles; \$1.30
- (C) 2-liter bottle; \$2.80
- (D) Box of six $\frac{1}{2}$ -liter bottles; \$3.90

15. Which equation represents the data shown in the table below?

| x | y |
|---|----|
| 2 | 9 |
| 3 | 12 |
| 4 | 15 |
| 5 | 18 |

- (A) $y = 2x + 9$
- (B) $y = 3x + 3$
- (C) $y = 3x + 12$
- (D) $y = 4x + 1$

16. At Avery Middle School, 273 students responded to a survey asking whether a Bulldog, a Lion, or a Tiger should be the new school mascot. Four times as many students chose Bulldog as chose Tiger. Twice as many students chose Lion as chose Tiger. How many students chose Lion?

- (A) 39 students
- (B) 78 students
- (C) 156 students
- (D) 273 students

17. What is the area of the figure below?

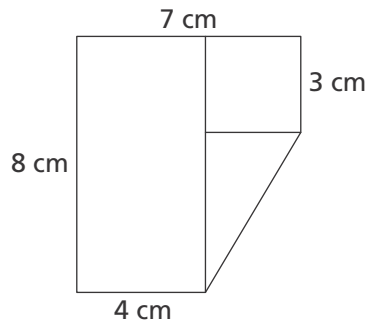

- (A) 22 cm^2
- (B) 24 cm^2
- (C) 48.5 cm^2
- (D) 56 cm^2

18. What percent of 50 is 15?

- (A) 0.3%
- (B) 7.5%
- (C) 30%
- (D) 35%

19. Which list of numbers is ordered from least to greatest?

- (A) $6\frac{3}{4}, 6.57, -6.53, -6\frac{1}{4}$
- (B) $-6.53, -6\frac{1}{4}, 6.57, 6\frac{3}{4}$
- (C) $6\frac{3}{4}, 6.57, -6\frac{1}{4}, -6.53$
- (D) $-6\frac{1}{4}, -6.53, 6.57, 6\frac{3}{4}$

20. What percent is represented by the diagram below?

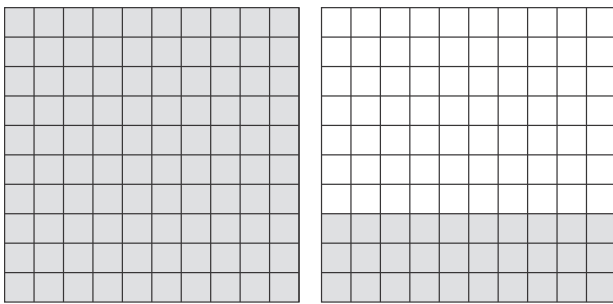

- (A) 13%
- (B) 65%
- (C) 130%
- (D) 650%

21. Solve the equation below for x .

$$x - 15.2 = 76$$

- (A) $x = 5$
- (B) $x = 60.8$
- (C) $x = 91.2$
- (D) $x = 1,155.2$

22. Which of the following is a list of equivalent numbers?

- (A) $1.25, 1\frac{1}{4}, 12.5\%$
- (B) $0.125, \frac{1}{4}, 12.5\%$
- (C) $12.5, 12\frac{1}{2}, 125\%$
- (D) $1.25, 1\frac{1}{4}, 125\%$

23. The boiling point of water is 212°F . The boiling point of helium is -452°F . How would you compare the temperatures using an inequality?

- (A) $-452^\circ\text{F} < 212^\circ\text{F}$
- (B) $-452^\circ\text{F} > 212^\circ\text{F}$
- (C) $212^\circ\text{F} < -452^\circ\text{F}$
- (D) $212^\circ\text{F} > 452^\circ\text{F}$

24. Sierra and Alek each have five cousins. Their ages are listed below.

Sierra's cousins: 2, 11, 12, 13, 15

Alek's cousins: 9, 11, 11, 12, 13

Which of the following statements is true?

- (A) For both sets of data, the median is equal to the mean.
- (B) The ages of Sierra's cousins are more spread out than those of Alek's cousins.
- (C) The mean age of Sierra's cousins is greater than that of Alek's cousins.
- (D) There are no outliers.

25. What is the greatest common factor of 60 and 75?

- (A) 3
- (B) 6
- (C) 15
- (D) 25

26. A quadrilateral is graphed on a coordinate plane. If the vertices are $A(2, 6)$, $B(6, 0)$, $C(2, -6)$ and $D(-4, 0)$, which two points are farthest apart?

- (A) A and B
- (B) B and D
- (C) A and C
- (D) C and D

27. What is the volume of the rectangular prism?

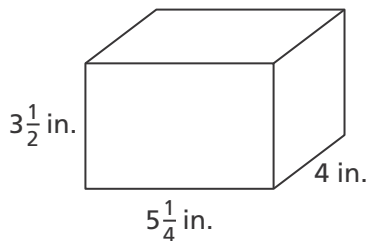

- (A) $12\frac{1}{6} \text{ in.}^3$
- (B) 24 in.^3
- (C) $60\frac{1}{8} \text{ in.}^3$
- (D) $73\frac{1}{2} \text{ in.}^3$

28. Isa finished 30% of his homework in 27 minutes. How many more minutes will it take Isa to complete his homework, assuming that he works at the same pace?

- (A) 63 minutes
- (B) 67 minutes
- (C) 70 minutes
- (D) 90 minutes

29. Bella is wrapping a cube-shaped gift box that measures 8.5 inches along each edge. How many square inches of wrapping paper is needed to cover the box completely without overlapping?

- (A) 34 in.^2
- (B) 72.25 in.^2
- (C) 433.5 in.^2
- (D) 614.125 in.^2

30. What is the area of this trapezoid?

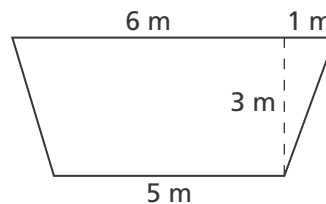

- (A) 14 m^2
- (B) 18 m^2
- (C) 21 m^2
- (D) 35 m^2

31. Which of the following is a statistical question?
- (A) What state were you born in?
 - (B) How tall is Ms. Lin?
 - (C) What are the ages of the students in your class?
 - (D) What is the formula for the circumference of a circle?

32. Solve the equation below for x .
 $3.25x = 8.125$

- (A) $x = 0.025$
- (B) $x = 0.25$
- (C) $x = 2.5$
- (D) $x = 25$

33. Which pair of expressions is equivalent?

- (A) $15a + 6$ and $3(5a + 3)$
- (B) $14b + 4$ and $2(7b - 2)$
- (C) $5(2c + 3)$ and $7c + 8$
- (D) $3\left(d + \frac{5}{3}\right)$ and $3d + 5$

34. A recipe calls for 3 avocados for each bowl of guacamole. How many full bowls of guacamole can be made with 17 avocados?

- (A) 3 bowls
- (B) 5 bowls
- (C) 6 bowls
- (D) 14 bowls

35. Which coordinate pair represents the reflection of $(-4, 6)$ across the x -axis?

- (A) $(4, -6)$
- (B) $(-4, 6)$
- (C) $(-4, -6)$
- (D) $(4, 6)$

36. Which of the following can be represented by the equation $y = 2x + 3$?

Table A

| x | y |
|-----|-----|
| 2 | 3 |
| 4 | 6 |
| 6 | 8 |

Graph B

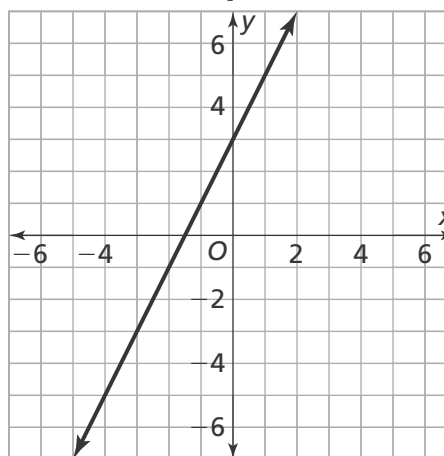

- (A) Table A only
- (B) Graph B only
- (C) Table A and Graph B
- (D) Neither Table A nor Graph B